

Instruction Manual

HITACHI

Washing Machine

Front Loading

Model

BD-802HVOW BD-1054HVOW
BD-D802HVOW BD-D1054HVOS
BD-904HVOW BD-D1054HVOW
BD-1054HVOS

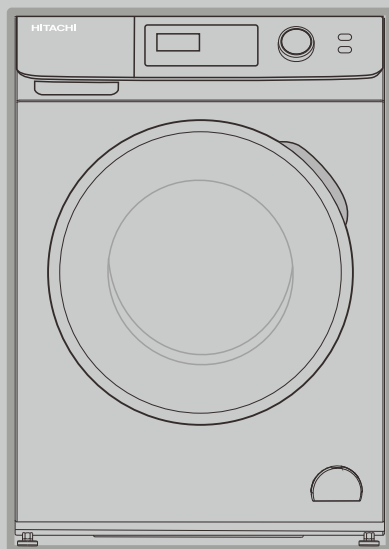

Thank you for purchasing a Hitachi front loading washing machine.

- Please read this Instruction Manual carefully for proper operation of the machine.
- Please keep this Instruction Manual for future reference.

Content

Safety Instructions

- Safety Instructions 2

Installation

- Product Description 7
- Installation 8

Operations

- Quick Guide 13
- Before Each Washing 14
- Detergent Dispenser 15
- Control Panel 16
- Display Panel 17
- Option 18
- Other Function 19
- Programs 20
- Washing Programs Table 22
- Duvet program 23

Maintenances

- Cleaning And Care 24
- Troubleshooting 28
- Error Codes..... 29
- Technical Specifications 30

Safety Instructions

Safety Instructions

For your safety, the information in this manual must be followed to minimize the risk of fire or explosion, electric shock, or to prevent property damage, personal injury or loss of life.

Explanation of the symbols:

WARNING

This combination of symbol and signal word indicates a potentially dangerous situation which may result in death or serious injuries unless it's avoided.

CAUTION

This combination of symbol and signal word indicates a potentially dangerous situation which may result in slight or minor injuries or damage to property and the environment.

NOTE

This combination of symbol and signal word indicates a potentially dangerous situation which may result in slight or minor injuries.

CAUTION



This symbol shows that the Operation Manual should be read carefully

WARNING

The electric shock!

- If the supply cord is damaged, it must be replaced by the manufacturer, its service agent or similarly qualified persons in order to avoid a hazard.

Safety Instructions

- This appliance is intended to be used in household and similar applications such as: (IEC 60335-2-7)
 - staff kitchen areas in shops, offices and other working environments;
 - farm houses;
 - by clients in hotels, motels and other residential type environments;
 - bed and breakfast type environments;
 - areas for communal use in blocks of flats or in launderettes.
- Do not dismantle, repair or modify the appliance. This could cause malfunction, fire, electric shock or injury. For repair, please contact your local service center.
- The new hose-sets supplied with the appliance are to be used and that old hose-sets should not be reused.
- Before any maintenance the device, unplug the appliance from the mains.
- Always unplug the machine and turn off the water supply after use.
- Do not pour water on the machine when it is running. This could cause an electric shock.
- To ensure your safety, power plug must be inserted into an earthed three-pole socket. Check carefully and make sure that your socket is properly and reliably earthed.
- Make sure that the water and electrical devices must be connected by a qualified technician in accordance with the manufacturer's instructions and local safety regulations.
- Do not insert the plug with a wet hand.
- Use the rated mains voltage and do not connect another plug at the same socket.
- Do not use a mains plug adaptor or an extension cable.
- This appliance is not intended for use by persons (including children) with reduced physical, sensory or mental capabilities, or lack of experience and knowledge, unless they have been given supervision or instruction concerning use of the appliance by a person responsible for their safety.

Risk to children!

- Children should be supervised to ensure that they do not play with appliance.
- Animals and children may climb into the machine. Check the machine before every operation.

Safety Instructions

- Glass door may be very hot during the operation. Keep kids and pets far away from the machine during the operation.
- Remove all packages and transport bolts before using the appliance. Otherwise, serious damage may result.
- Plug must be accessible after installation.
- The appliance must not be installed behind a lockable door, a sliding door or a door with a hinge on the opposite side to that of the washer.

Risk of explosion!

- Do not wash or dry articles that have been cleaned in, washed in, soaked in, or dabbed with combustible or explosive substances (such as wax, oil, paint, gasoline, degreasers, dry-cleaning solvents, kerosene, etc.) This may result in fire or explosion.
- The washer is not to be used if industrial chemicals have been used for cleaning.
- The lint trap has to be cleaned frequently, if applicable.
- The lint must not be allowed to accumulate around the washer.
- Beforehand thoroughly rinse items of washing by hand.

CAUTION

Installing the product!

- The installation of the appliance should be done by the manufacturer's dealer or service agent.
- This washing machine is for indoor use only.
- It isn't intended to be built-in using.
- The openings must not be obstructed by a carpet.
- Washing machine shall not be installed in bath room or very wet rooms as well as in the rooms with explosive or caustic gases.
- The washing machine with single inlet valve only can be connected to the cold water supply. The product with double inlet valves should be correctly connected to the hot water and cold water supply.
- Plug must be accessible after installation.
- If there is a water outage or you remove the water supply hose and reattach it, turn off the tap and press the Start/Pause button, then turn on the tap slowly after 40 seconds.
Air pressure could damage the washing machine if there is a lot of air in the water pipe.

Safety Instructions

Risk of damaging appliance!

- Your product is only for home use and is only designed for the textiles suitable for machine washing.
- Do not climb up and sit on top cover of the machine.
- Do not lean against machine door.
- Do not put heavy objects on the washing machine.
- Cautions during Handling Machine:

1. Transport bolts shall be reinstalled to the machine by a specialized person.
2. The accumulated water shall be drained out of the machine.
3. Handle the machine carefully. Never hold each protruded part on the machine while lifting. Machine door can not be used as the handle during the conveyance.
4. This appliance is heavy. Transport with care.

- Please do not close the door with excessive forces. If it is found difficult to close the door, please check if the clothes are put in or distributed well.
- It is forbidden to wash carpets.

Operating the appliance!

- Before washing the clothes at first time, the product shall be operated in one round of the whole procedures without the clothes inside.
- Flammable and explosive or toxic solvents are forbidden. Gasoline and alcohol etc. shall not be used as detergents. Please only select the detergents suitable for machine washing, especially for drum.

Safety Instructions

- Do not wash waterproof items such as raincoats, wet suits, ski suits, sleeping bags, cushions, pillows, shoes, etc. The washing machine may not work properly, or the items may cause injury or damage the machine. Do not wash the laundry even if it is labeled as washable with waterproof clothing.
- If detergent, fabric softener or bleach spills on the surface of the machine, clean it up with a damp cloth immediately. The plastic or steel parts of the washing machine may get damaged.
- Do not place heat sources near the washing machine. This may cause deformation of the machine.
- Make sure that all pockets are emptied. Sharp and rigid items such as coin, brooch, nail, screw or stone etc. may cause serious damages to this machine.
- Please check whether the water inside the drum has been drained before opening its door. Please do not open the door if there is any water visible.
- Be careful of burning when the product drains hot washing water.
- Never refill the water by hand during washing.
- Adequate ventilation has to be provided to avoid the back flow of gases into the room from appliances burning other fuels, including open fires.
- Fabric softeners, or similar products, should be used as specified by the fabric softener instructions.
- Remove all objects from pockets such as lighters and matches before use the appliance.
- **WARNING:** The appliance must not be supplied through an external switching device, such as a timer, or connected to a circuit that is regularly switched on and off by a utility.

Packaging/Old appliance



This marking indicates that this product should not be disposed with other household wastes throughout the EU. To prevent possible harm to the environment or human health from uncontrolled waste disposal, recycle it responsibly to promote the sustainable reuse of material resources. To return your used device, please use the collection systems or contact the retailer where the product was purchased. They return and can take this product for environmental safe recycling.

Installation

Product Description

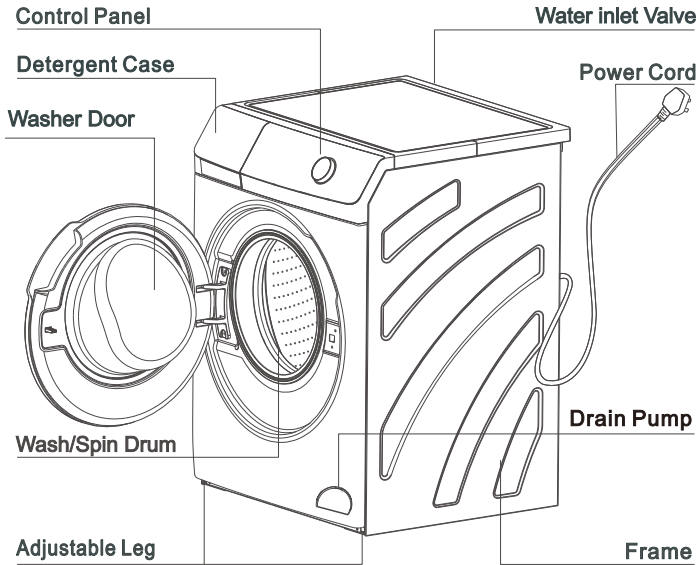

NOTE

The product line chart is for reference only, please refer to real product as standard.

Accessories



Cover Caps
(4pcs.)



Supply Hose



Screw
(9pcs.)
Screws for fixing
the Bottom panel cover



Instruction Manual



Bottom Panel Cover

Installation

Installation area

WARNING

- Stability is important to prevent the product from wandering!
- Make sure that the product should not stand on the power cord.

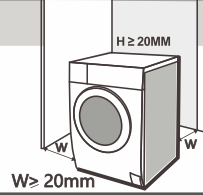

Before installing the machine, the location characterized follows shall be selected:

1. Rigid, dry, and level surface
2. Avoid direct sunlight
3. Sufficient ventilation
4. Room temperature is above 0°C
5. Keep far away from the heat resources such as coal or gas.

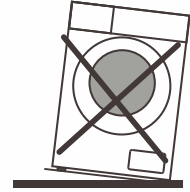

Unpacking the washing machine

WARNING

- Packaging material (e.g. Films, Styrofoam) can be dangerous for children.
- There is a risk of suffocation ! Keep all packaging well away from children.

1. Remove the cardboard box and styrofoam packing.
2. Lift the washing machine and remove the base packing. Make sure the small triangle foam is removed with the bottom one together. If not, lay the unit down with side surface, then remove the small foam from the unit bottom manually.
3. Remove the tape securing the power supply cord and drain hose.
4. Remove the inlet hose from the drum.

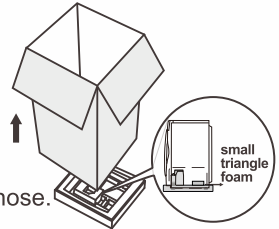

Remove transport bolts

WARNING

- You must remove the transport bolts from the backside before using the product.
- You'll need the transport bolts again if you move the product, so make sure keep them in a safe place.

Please take the following steps to remove the bolts:

1. Loosen 4 bolts with spanner and then remove them.
2. Stop the holes with Cover Caps.
3. Keep the transport bolts properly for future use.

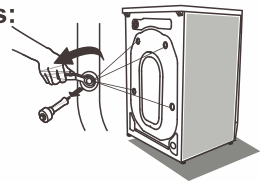

Installation

Leveling the washing machine

WARNING

- The lock nuts on all four feet must be screwed tightly against the housing.
- Check the alignment of the washing machine with level, and adjust the feet if it's not aligned.

1. Check if the legs are closely attached to the cabinet. If not, please turn them to their original positions tighten the nuts.
2. Loosen the lock nut turn the feet until it closely contacts with the floor.
3. Adjust the legs and lock them with a spanner.
4. Make sure the machine is steady.

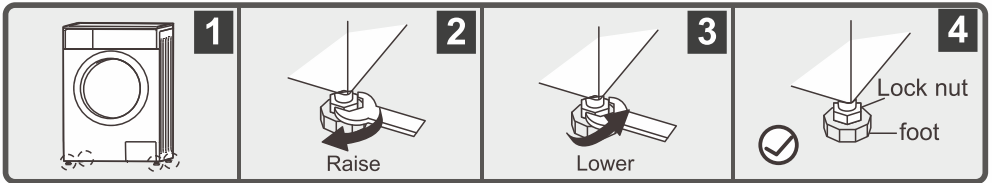

Connect Water Supply Hose

WARNING

- To prevent leakage or water damage, follow the instructions in this chapter.
- Do not kink, crush, modify or sever water inlet hose.
- For the model equips hot valve, connect it to hot water tap with hot water supply hose. Energy consumption will decrease automatically for some program.

Connect the inlet pipe as indicated. There are two ways to connect the inlet pipe.

1 Connection between ordinary tap and inlet hose.

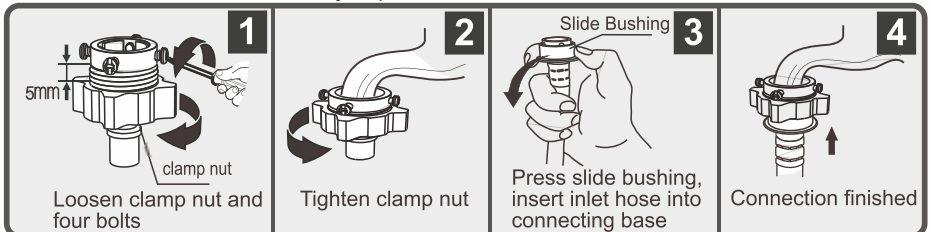

Installation

2 Connection between screw tap and inlet hose.

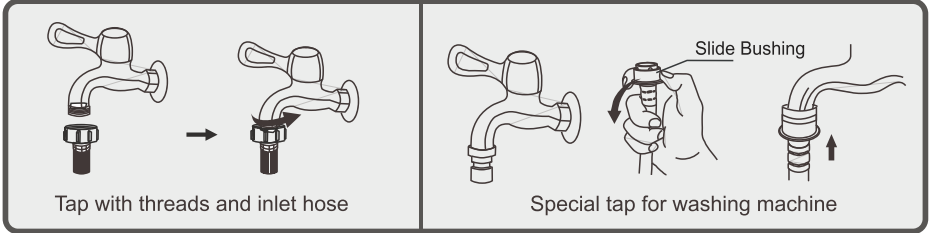

- Connect the other end of inlet pipe to the inlet valve at the backside of product and fasten the pipe tightly clockwise.
- Optimum water pressure is 0.03 ~ 1.0MPa.

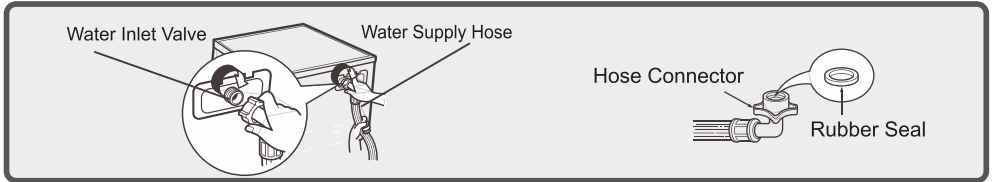

Drain Hose

⚠ WARNING

- Do not kink or protract the drain hose.
- Position drain hose properly, otherwise damage might result of water leakage.

There are two ways to place the end of drain hose:

1. Put it into the water trough.

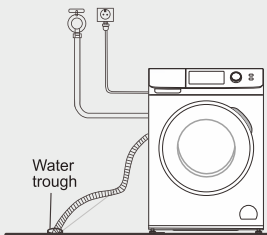

2. Connect it to the branch drain pipe of the trough.

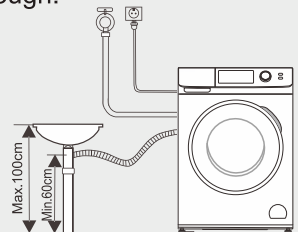

WARNING

- When installing drain hose, fix it properly with a rope.
- If drain hose is too long, do not force it into washing machine as it will cause abnormal noises.

■ Bottom panel cover

WARNING

- Please install before removing the transport fixing bolts. At least two people are required for installation.
- Before installing the bottom panel cover, the faucet must be turned off, and the connection between the power cord and the external power socket, the water inlet pipe and the water inlet faucet, and the drain pipe and the drain should be disconnected.

The installation steps are as follows:

1. Take out the bottom panel cover and remove the double-sided tape around the cover plate.
2. Tilt the washing machine backwards, and slowly lay it down on the cushion.
Note that the control panel of the washing machine should face forward.
3. Aim the sound-absorbing sponge on the bottom panel cover toward the inside of the washing machine, the positioning hole is on the left side. Aligning the screw holes around the bottom panel cover to the screw holes on the washing machine bottom plate. Press around the bottom panel cover, and paste it to the washing machine bottom plate.
4. Fix the left side, right sides and the back side of the bottom panel cover with special screws (large round cap screws which is provided in the bag) and then gently lift the washing machine and place it stably.

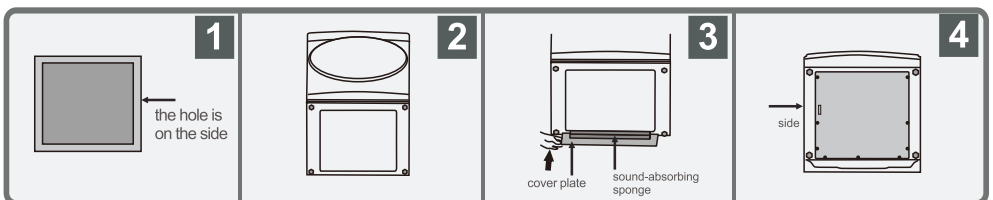

Installation

Checking operation

Checking after installation

- 1 Turn on the water tap and close the washing machine door.
- 2 Press the Power button to switch power on.
- 3 Select the cotton program and press the Start/Pause button.
- 4 After 5 minutes, check if there is no water leakage from anywhere.
- 5 Press the Power button to switch power off.
- 6 Press the Power button again to switch power on.
- 7 Select the Spin program and press the Start/Pause button.
- 8 Check if there is no abnormal vibration or sound, and that water is drained out properly.
- 9 Press the power button to switch power off.
- 10 Press the power button again to switch power on.
- 11 Select the dry program by knob and press the dry button, then press the Start/Pause button.
- 12 Check if there is a sound of wind (the operation of drying fan).

If any of the following conditions or other abnormalities occur, immediately pull out the power plug to prevent an accident and contact your local service center.

- **The washing machine does not operate when you switch power on.**
- **The power cord has cracks.**
- **There are abnormal vibrations and sounds during operation.**
- **There is a smell of burning.**

Operations

Quick Guide

⚠ CAUTION

- Before washing, please make sure it's installed properly.
- Before washing at first time, the washing machine shall be operated in one of the whole procedures without clothes in as follows.

1 Before Washing

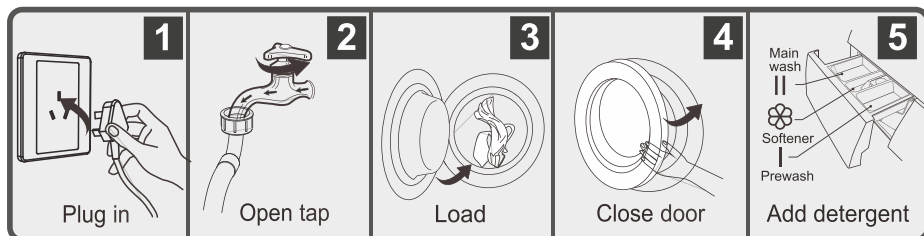

NOTE

- Both powder detergent and liquid detergent can be used in Case I and Case II. But if Prewash is selected, please only use powder detergent in "Case II".

2 Washing

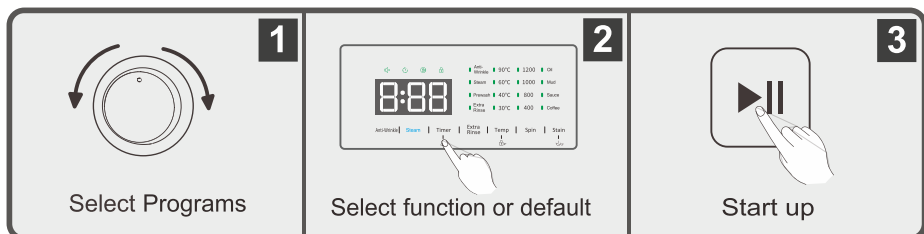

NOTE

- If default is selected, step 2 can be skipped.

3 After Washing

Beeping, then power off automatically.

Operations

Before Each Washing

- The working condition of the washer should be 0-40°C. If used under 0°C, the inlet valve and draining system may be damaged. If the machine is placed under condition of 0°C or less, then it should be transferred to normal ambient temperature to ensure the water supply hose and drain hose are not frozen before use.
- Please check the labels and the explanation of using detergent before wash. Use non-foaming or less-foaming detergent suitable for machine washing properly.



Check the label



Take out the items out of the pockets



Knot the long strips, zip or button



Put small clothes into the washing net



Turn easy-pilling and long-pile fabric inside out



Separate clothes with different textures

WARNING

- When washing and drying a single clothes, it may easily cause great eccentricity. Therefore it is suggested to add one or two more clothes to be washed together so that spinning can be done smoothly.
- Don't washing and drying the clothes touching with kerosene, gasoline, alcohol and other flammable materials.
- Washing and drying the following items may cause injury or malfunction due to abnormal vibration.
 - Waterproof items such as a wet suit, ski suit, etc.
 - Anti-slip treated items with rubber bottoms such a doormat.
 - Cushions, pillows, shoes, etc.
 - Do not put the fabric which can absorb the water very well (towel, jeans, etc.) in the washing net when washing.

Operations

Detergent Dispenser

- I Pre wash detergent
- II Main wash detergent
- ☼ Softener

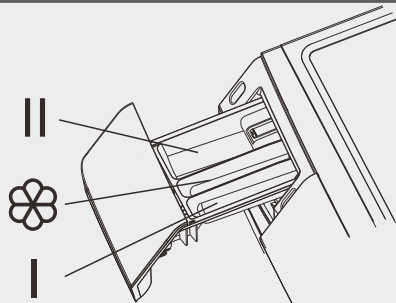

⚠ CAUTION

- Both powder detergent and liquid detergent can be used in Case I and Case II. But if Prewash is selected, please only use powder detergent in "Case II".
- Use the amount of detergent recommended on the detergent package. The type and amount of detergent depends on the type of fabric, load size, degree of soiling and hardness of the water used. Use less detergent if : You wash a small load and the laundry is slightly soiled.
- Too much detergent can result in excess foam formation which reduces rinse efficiency or may cause a water leak.

Programs	I	II	☼	Programs	I	II	☼
Quick Start	○	●	●	Tub Wash	○	○	○
Mix	●	●	●	Rinse & Spin	○	○	●
Cotton	●	●	●	Spin	○	○	○
Wool	○	●	●	Dry	○	○	○
Rapid	○	●	●	Delicate	○	●	●
Jeans	●	●	●	1 Hour Wash & Dry	○	●	●
Under Wear	○	●	●	Baby Care	●	●	●
Duvet	○	●	●	Color	○	●	●
Hygiene	○	●	●	Mix Wash & Dry	○	●	●
Shirt	●	●	●	Cotton Eco	○	●	●

● Means optional ○ Means Non-optional

NOTE

- As for the agglomerated or ropy detergent or additive, before they are poured into the detergent box, it is suggested to use some water for dilution to prevent the inlet of detergent box from being blocked and overflowing while filling water.
- Please choose suitable type of detergent for the various washing temperature to get the best washing performance with less water and energy consumption.

Operations

Control Panel

Model: BD-802HVOW/BD-D802HVOW/BD-904HVOW/BD-1054HVOS/BD-1054HVOW/
BD-D1054HVOS/BD-D1054HVOW

5 Display

The display shows the settings, estimated time remaining, options, and status messages for your washer. The display will remain on through the cycle.

2 Start/Pause

Press the button to start or pause the washing cycle.

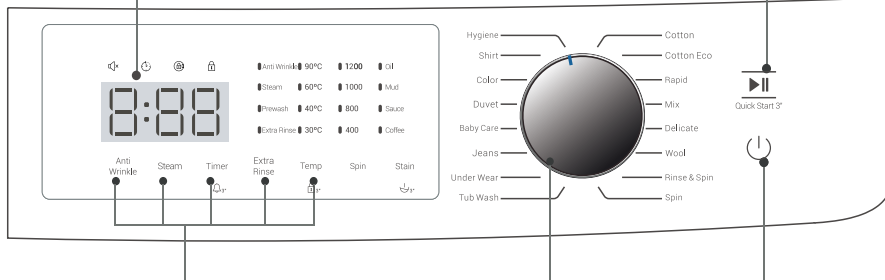

3 Option

This allows you to select an additional function.

4 Programs

Available according to the laundry type.

1 Power

Product is on/off.

NOTE

- The chart is for reference only, please refer to real product as standard.

Operations

Display Panel

Model: BD-802HVOW/BD-D802HVOW/BD-904HVOW/BD-1054HVOS/BD-1054HVOW/
BD-D1054HVOS/BD-D1054HVOW

Display

Washer type

The diagram shows the control panel of a washer. Callout A points to the digital display showing '8:88'. Callout B points to the 'Anti-Wrinkle' button. Callout C points to the 'Steam' button. Callout D points to the 'Prewash' button. Callout E points to the 'Extra Rinse' button. Callout F points to the 'Temperature' button. Callout G points to the 'Spin' button. Callout H points to the 'Stain' button. Callout I points to the 'Timer' button. The panel also features a speaker icon, a power icon, a child lock icon, and a door lock icon. The display shows various settings: Anti-Wrinkle (90°C), Steam (60°C), Prewash (40°C), Extra Rinse (30°C), Spin (1200), and Stain (Oil, Mud, Sauce, Coffee).

A Display	
Wash Time (h:min)	Delay Time
8:25	2h
Anti-Wrinkle	Error
[-] []	E II

B Functions	C Temp
D Spinspeed	E Stains
F Silence	G Timer
H Child Lock	I Door Lock

Dryer type

The diagram shows the control panel of a dryer. Callout A points to the digital display showing '8:88'. Callout B points to the 'Dry' button. Callout C points to the 'Steam' button. Callout D points to the 'Prewash' button. Callout E points to the 'Extra Rinse' button. Callout F points to the 'Temperature' button. Callout G points to the 'Spin' button. Callout H points to the 'Stain' button. Callout I points to the 'Timer' button. The panel also features a speaker icon, a power icon, a child lock icon, and a door lock icon. The display shows various settings: Dry (90°C), Steam (60°C), Prewash (40°C), Extra Rinse (30°C), Spin (1200), and Stain (Oil, Mud, Sauce, Coffee).

A Display	
Wash Time (h:min)	Delay Time
8:25	2h
Anti-Wrinkle	Error
[-] []	E II

B Functions	C Temp
D Spinspeed	E Stains
F Dryer	G Timer
H Child Lock	I Door Lock

Operations

Option

 **Prewash:** Long press the function button 3s to enter the prewash function.
The Prewash function can get an extra wash before main wash. It is suitable for washing the dust rises to surface of the clothes. Please only put powder detergent into the Case (I) to do the prewash.

Extra Rinse **Extra Rinse:** Press the Function button to choose
The laundry will undergo 1 extra rinse after selecting.

 **Method**
1. Open the power and choose the suitable program and buttons according to user's requirement
Press the timer button to set the finishing time.
Press the start/stop button to start-up the delay wash function.
(Delay time has every one hour interval and maximum is 24hours.)

Attention
1. If need to change the reservation, please press power button and set again.
2. After reservation, user can cancel it if press power button.
3. When confirm the delay wash, please press the timer button. The setting time will display for 5 seconds.
4. Reservation time is different in the different condition. It depends on water pressure, drain clothes type, water temperature.
5. Timer function can not be used when using auto dry program.

Stain **Stain**
Select the four stains as needed. Depending on the capacity and type of detergent, stains may come off in different degrees. When you want to remove dirt more effectively, clothes around 3 kg are recommended.

Programme	Option				Programme	Option			
	Prewash	Extra rinse	Timer	Stain		Prewash	Extra rinse	Timer	Stain
Quick Start	<input type="radio"/>	<input type="radio"/>	<input type="radio"/>	<input type="radio"/>	Tub Wash	<input type="radio"/>	<input type="radio"/>	<input checked="" type="radio"/>	<input type="radio"/>
Mix	<input checked="" type="radio"/>	<input checked="" type="radio"/>	<input checked="" type="radio"/>	<input checked="" type="radio"/>	Rinse & Spin	<input type="radio"/>	<input checked="" type="radio"/>	<input checked="" type="radio"/>	<input type="radio"/>
Cotton	<input checked="" type="radio"/>	<input checked="" type="radio"/>	<input checked="" type="radio"/>	<input checked="" type="radio"/>	Spin	<input type="radio"/>	<input type="radio"/>	<input checked="" type="radio"/>	<input type="radio"/>
Wool	<input type="radio"/>	<input checked="" type="radio"/>	<input checked="" type="radio"/>	<input type="radio"/>	Dry	<input type="radio"/>	<input type="radio"/>	<input checked="" type="radio"/> *	<input type="radio"/>
Rapid	<input type="radio"/>	<input checked="" type="radio"/>	<input checked="" type="radio"/>	<input type="radio"/>	Delicate	<input type="radio"/>	<input checked="" type="radio"/>	<input checked="" type="radio"/>	<input type="radio"/>
Jeans	<input checked="" type="radio"/>	<input checked="" type="radio"/>	<input checked="" type="radio"/>	<input checked="" type="radio"/>	1 Hour Wash & Dry	<input type="radio"/>	<input type="radio"/>	<input checked="" type="radio"/>	<input type="radio"/>
Under Wear	<input type="radio"/>	<input checked="" type="radio"/>	<input checked="" type="radio"/>	<input checked="" type="radio"/>	Baby Care	<input checked="" type="radio"/>	<input checked="" type="radio"/>	<input checked="" type="radio"/>	<input type="radio"/>
Duvet	<input type="radio"/>	<input checked="" type="radio"/>	<input checked="" type="radio"/>	<input checked="" type="radio"/>	Color	<input type="radio"/>	<input checked="" type="radio"/>	<input checked="" type="radio"/>	<input type="radio"/>
Hygiene	<input type="radio"/>	<input checked="" type="radio"/>	<input checked="" type="radio"/>	<input type="radio"/>	Mix Wash & Dry	<input type="radio"/>	<input checked="" type="radio"/>	<input type="radio"/>	<input type="radio"/>
Shirt	<input checked="" type="radio"/>	<input checked="" type="radio"/>	<input checked="" type="radio"/>	<input checked="" type="radio"/>	Cotton Eco	<input type="radio"/>	<input checked="" type="radio"/>	<input checked="" type="radio"/>	<input type="radio"/>

● Means optional ○ Means Non-optional

* Press dry function under the screen to choose auto or timer. Screen shows 30,60... for timer.

Temp **Temp:** Press the Temp button to choose
Press the button to regulate the temperature (30°C, 40°C, 60°C, 90°C)

 **Anti-wrinkle**
After the program runs, add about 8 hours of clothing shaking process to care the cloth. Anti-wrinkle function can not be used with Dry, Tub wash, Cotton Eco, Quick start program.

Operations

Other Function

Spin

Spin : Press the Spin button to choose

Press the button to change the speed.

8kg model: 400-800-1000-1200 9kg/10.5kg model: 400-800-1000-1400

Steam

Using steam protects clothes and reduce bacteria in high temperature washing program. When selecting steam, there will be 30min steam function after washing, then it will start to rinse.

* Water temp is set to be 60°C

Dry

This function is to dry clothes. Press the dry button to switch between auto dry and timer dry. Only timer dry can choose the drying time and delay function (timer button).

Programme	Default speed (r/m) 8 kg model	Default speed (r/m) 9kg/10.5kg model	Anti-wrinkle	Dry	Steam
Quick Start	800	800			
Mix	800	800	●	●	●
Cotton	800	800	●	●	●
Wool	800	800	●		
Rapid	800	800	●		
Jeans	800	800	●	●	
Under Wear	800	800	●		
Duvet	800	800	●		
Hygiene	800	800	●	●	●
Shirt	800	800	●	●	●
Tub Wash	800	800		●	
Rinse & Spin	800	800	●	●	
Spin	800	800	●	●	
Dry	\	\		●	
Delicate	800	800	●		
1 Hour Wash & Dry	1200	1400		● Default	
Baby Care	800	800	●		
Color	800	800	●		
Mix Wash & Dry	1200	1400		● Default	
Cotton Eco	800	1400		●	



Child Lock: To avoid misoperation by children.

User can set child lock function in order to avoid child operate the machine when it is working.

So the door can not be opened and the button except power button cannot be handled. When cancel this function, door can be opened again.

Set/Cancel method

Open the power and press [Temp] button for 3 seconds till the buzzer sound.

The child lock function is finished to set. If repeat this action, the child lock function will be cancelled.



Mute the buzzer :

Choose the Programme > Press the [Timer] button for 3sec., after 2 beeps, the buzzer is mute. To activate the buzzer function, press the button again for 3 seconds. The setting will be kept until the next reset.

*For dryer model, the buzzer on/off will be indicated by beeping only

⚠ CAUTION

- After muting the buzzer function, the beep sound when washing is over will not be activated any more.

Reload

Reload:

You can add fabric when your press [Start/Pause] button .

Before the water high level and the temperature up to 60°C.

Operations

Programs

Programs are available according to the laundry type.

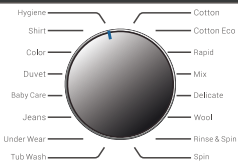

Cotton	For daily washing of cotton and linen items such as shirts, towels, bed linen and table linen.
Hygiene	High temp wash for cotton and linen clothes
Baby Care	Washing the baby's clothes, it can make the baby's wear cleaner and make the rinse performance better to protect the baby skin.
Shirt	Wash of shirts
Mix	Mixed load consisting of textiles made of cotton and synthetics.
Color	Wash of clothes with deep color or light color
Jeans	Wash of jeans
Rapid	Extra short program which is only suitable to wash small amount of laundry. Load limitation is 1kg(about 4 shirts). Default spin speed is 800rpm. If you think the moisture content after spin is not what you want, please choose 1000 or higher spin speed.
Wool	Hand or machine - washable wool or rich wool textiles. Especially gentle wash program to prevent shrinkage, longer program pauses (textiles rest in wash liquor).
Spin	Extra spin with selectable spin speed.
Cotton Eco	For cotton and linen items. Eco operation that saves energy and water that provides the same washing performance as the Cotton program.
Tub Wash	Specially set in this machine to clean the drum and tub. It applies 90 °C high temperature sterilization to make the clothes washing more clean. When this programme is performed, the clothes or other washing cannot be added. When proper amount of chlorine bleaching agent is put in, the barrel cleaning effect will be better. The customer can use this programme regularly according to the need.

Operations

Programs

Programs are available according to the laundry type.

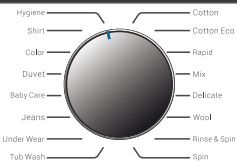

Duvet	This program is specially designed for washing duvet coats.
Delicate	For delicate washable, e.g. made of silk, satin, underwear, synthetic fibres or blended fabrics.
Under Wear	Wash of underwear
Rinse & Spin	For clothes which just needs rinse and spin
Mix Wash & Dry	This is a program for mix washing and drying the Cotton, linen and chemical fiber fabrics. (for wash&dryer model only)
1Hour Wash & Dry	This is a program for quick wash and dry. It is for synthetic clothes or shirt. Load limitation is only 1kg(about 4 shirts). Remark: Big towels or jeans is not suitable for this program, they will extend the time duration and affect the moisture content.
Dry	To dry clothes (for wash&dryer model only). After selecting dry program, you can press the dry button (under the screen) to select auto dry or timer dry. Only timer dry can choose the drying time and delay function (timer button).
Quick Start	The quick start button must be pressed for 3 seconds in the situation of the washing machine being powered off.

Operations

Washing Programs Table

Model: BD-802HVOW/BD-D802HVOW/BD-904HVOW/BD-1054HVOS/BD-1054HVOW/
BD-D1054HVOS/BD-D1054HVOW

Programs	Maximum wash Load			Maximum dryer Load	
	8 kg	9 kg	10.5 kg	8 kg	10.5 kg
Quick Start	6	6.5	7		
Mix	6	6.5	7	5	7
Cotton	8	9	10.5	5	7
Wool	2	2	2		
Rapid	1	1	1		
Jeans	5	5	5	5	5
Under Wear	3	3	3		
Duvet	2	2	2		
Hygiene	4	4	4	4	4
Shirts	3	3	3	3	3
Tub Wash					
Rinse & Spin	8	9	10.5	5	7
Spin	8	9	10.5	5	7
Dry				5	7
Delicate	3	3	3		
1 Hour Wash & Dry	1	1	1	1	1
Baby Care	4	4	4		
Color	3	3	3		
Mix Wash & Dry	6	6	6	6	7
Cotton Eco	8	9	10.5	5	7

NOTE

- The parameters in this table are only for user's reference. The actual parameters maybe different with the parameters in above mentioned table.

Operations

Duvet program

NOTE

- Do not use washing net. This may cause excessive vibration when spinning.

1 Load the laundry

Fold a large items such as a duvet or blanket as follows.

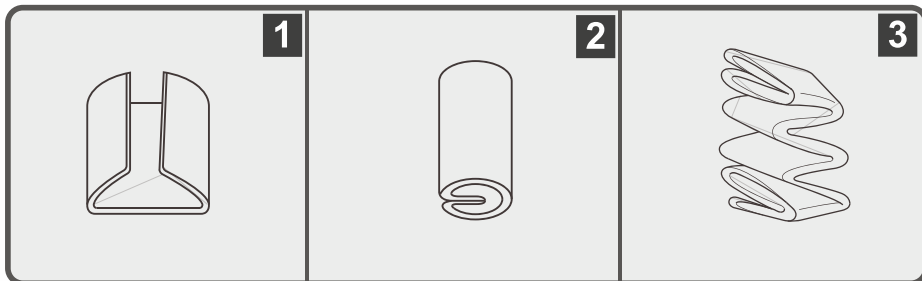

Load laundry into the drum with the ends facing the rear of the drum.

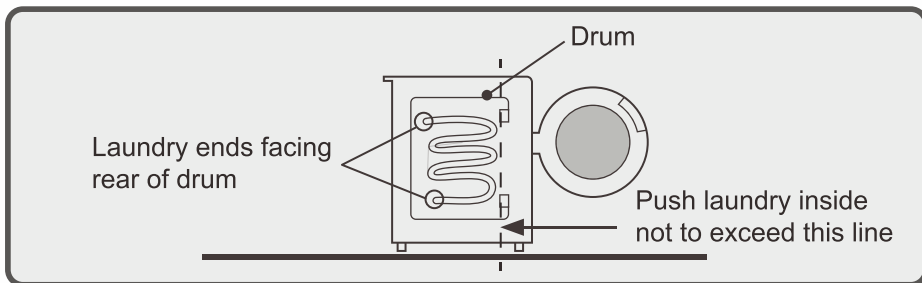

2 Press the Power button to switch power on.

3 Select the Duvet program.

4 Add detergent into the detergent dispenser.

5 Press the Start /Pause button.

Maintenances

Cleaning And Care

WARNING

- Before your maintenance starts, please unplug the machine and close the tap.

1 Cleaning The Cabinet

Proper maintenance on the washing machine can extend its working life. The surface can be cleaned with diluted non-abrasive neutral detergents when necessary. If there is any water overflow, use the wet cloth to wipe it off immediately. No sharp items are allowed.



NOTE

- Formic acid and its diluted solvents or equivalent are forbidden, such as alcohol, solvents or chemical products, etc.

2 Cleaning The Drum

The rusts left inside the drum by the metal articles shall be removed immediately with chlorine-free detergents. Never use steel wool.

NOTE

- Formic acid and its diluted solvents or equivalent are forbidden, such as alcohol, solvents or chemical products, etc.

3 Cleaning The Door Seal And Glass

Wipe the glass and seal after each wash to remove lint and stains. If lint builds up, it can cause leaks.

Remove any coins, buttons and other objects from the seal after each wash.



CAUTION

- Do not apply too much force during door below cleaning because it may cause of door bellow take out and the water leakage problem.

Maintenances

Cleaning And Care

4 Cleaning The Inlet Filter

NOTE

- Inlet filter must be cleaned if there is less water.

Washing the filter in the tap

1. Close the tap.
2. Remove the water supply hose from the tap.
3. Clean the joint.
4. Reconnect the water supply hose.



Washing the filter in washing machine:

1. Screw off the inlet pipe from the backside of the machine.
2. Pull out the filter with long nose pliers and reinstall it back after being washed.
3. Use the brush to clean the filter.
4. Reconnect the inlet pipe.

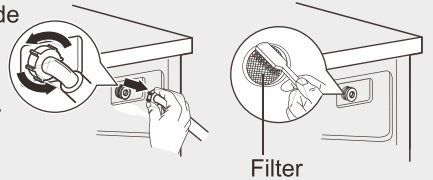

NOTE

- If the brush is not clean, you can pull out the filter washed separately.
- Reconnect, turn on the tap.

5 Cleaning The Detergent Dispenser

1. Press down the arrow location on Main detergent cover ("Case II" in the left) inside the detergent dispenser.
2. Take out softener cover and wash all grooves with water.
3. Restore the softener cover and push the detergent dispenser into position.

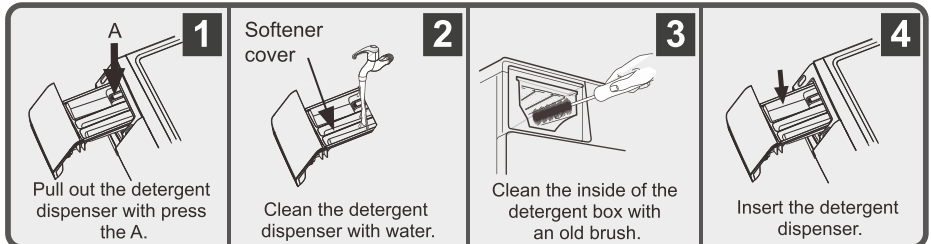

NOTE

- Do not use alcohol, solvents or chemical products to clean the machine.

Maintenances

Cleaning And Care

6 Using the drain hose to drain residual water

1. Unplug the washing machine's power cord.
2. Use a fingernail or a coin to pull open the filter cover.
3. Pull out the black drain hose from the fixed stop.
4. Unplug the drain cap at the front of the drain hose.
5. Let the water flow into the container.
6. Cover the drain cap and snap the drain hose back.
7. Close the filter cover.

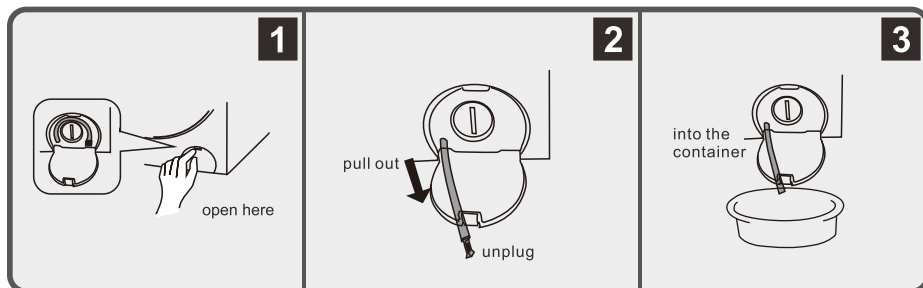

NOTE

- When the water temperature in the cylinder is too high, please cool it down.
- In the event of a power outage, empty the tub before removing the laundry.

7 Cleaning The Drain Filter

⚠ WARNING

- Be careful of the hot water!
- Allow detergent solution to cool down.
- Unplug the machine to avoid electrical shock before cleaning drain filter .
- Drain filter can filter the yarns and small foreign matters from the washing.
- Clean the filter periodically to ensure the normal operation of washing machine.
- Do not open the drain filter when a program is running.
- Do not operate the washing machine without the drain filter.

Maintenances

- 1
- Select the Spin program and start to drain remaining water in the drum.
 - Make sure to drain the water first with Spin program, otherwise a lot of hot water may come out.

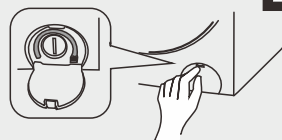

Open the lower cover cap

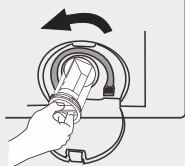

Open the filter by turning to the counter clockwise



Remove extraneous matter and clean the filter



Insert the filter and close the lower cover cap

⚠ CAUTION

- Make sure that the drain filter is installed correctly. Which should put the cover of the drain filter into the compartment, otherwise water may leak.
- When the appliance is in use and depending on the programme selected there can be hot water in the pump. Never remove the pump cover during a wash cycle, always wait until the appliance has finished the cycle, and is empty. When replacing the cover, ensure it is securely re-tightened.

8 Clean the dryer air outlet

In the continuous usage of the Washer Dryer, lint or dust might accumulate in the drying system affecting the airflow, drying time and the machine could be damaged. Please clean the airflow with small brush (similar like the tooth brush or cap brush) following below instructions.

Cleaning Instructions:

1. Put the brush under running water to make it wet.
2. Put the brush into the bellow space as indicated, twist the brush inwards and pull out. Lint accumulated will be pulled out.
3. Repeat steps 1 and 2 until all lints visible are cleaned away.



Clean all 4 areas
With the brush

NOTE

- Before cleaning it, please power off and unplug the machine.
- It is suggested to cleaning regularly based on the frequency of using the dryer function, better after every 100 drying cycles. If the drying level is insufficient or an error occurs during drying operation, please try to maintain this part as well.

Maintenances

Troubleshooting

The start of the appliance does not work or it stops during operation.
First try to find a solution to the problem, if not, contact the service centre.

Description	Reason
Door can't be opened	<ul style="list-style-type: none">• Water temperature is too high or power cut.• Setting child lock function.• The clothes is clamped between door and gasket.
Peculiar smell	<ul style="list-style-type: none">• Because using rubber components, it has rubber smell at the beginning.
Less water for washing and rinsing wash	<ul style="list-style-type: none">• Front load washer only need a little water
No water	<ul style="list-style-type: none">• Ensure the tap is turning on or not• Ensure the water pipe is froze or not• Ensure the filter is blockage or not
Halfway inflow the water	<ul style="list-style-type: none">• If the water level drop, the system will automatic filling water
Drainage when the machine is washing	<ul style="list-style-type: none">• Too much bubbly detergent
Residual time change	<ul style="list-style-type: none">• Washing machine will automatic filling water to keep balance, if the cloths are misdistribution.• The rest time is calculated based on 15L/min inflow. So according to different water pressure, time will be enlarged or shorten.• Washing machine will prolonged dehydration time, if the cloth appear tilt.
Dehydration process has abnormal sound	<ul style="list-style-type: none">• Is power line connect to cabinet?• Is the carriage bolts have been removed?• Is there a hairpin, coins or other foreign objects fall into drum?
Failure to work after power failure	<ul style="list-style-type: none">• When power cut off, the machine will not revolve. If recover the power, machine still not revolve, please press "power turn on/off" then reset program .
Emergency open door	<ul style="list-style-type: none">• When the power failure for a long time and you want to take out the clothes, unplug the power cord, waiting for the inner drum stop, pull down the emergency rope on the bottom right corner of cabinet, listening a slight noise then you can open the door. (Confirm the water level below the bucket and water temperature below 60°C in advance.)
Clothes do not dry	<ul style="list-style-type: none">• The spin may not reach to the highest speed. Please check whether the load is within limitation, take out the clothes and put back into the drum again to make it balance in the drum. Then only try the dry program again.• The inlet water temperature is too high, please try with cooler water. If the inlet temperature cannot be adjusted, please dry it again in the evening when room temperature is low.

Description	Reason
Clothes has high moisture content after spin	<ul style="list-style-type: none"> The spin speed is not suitable, please try with higher spin speed. If the speed already shows the highest but the clothes still have high moisture content after spin, it may not reach that speed because of the unbalance of load. Please take out the clothes and put back into the drum again to make it balance in the drum, then spin again.

NOTE

- After the check, activate the appliance. If the problem occurs or the display shows other alarm codes again, contact the service centre.

Error Codes

Fault code	Reason	Inspection point	Solution
No display	out of operation	<ul style="list-style-type: none"> Whether the outlet have electricity Whether the outlet is plugged in Power cut or not Leakage protector switch off or not Set up booking function or not 	
E11	No water	<ul style="list-style-type: none"> Tap turn on/off? Ensure the water pipe has been frozen or not Ensure the filter has been blockage or not Water stopped or not 	Press the Start/ Pause button
E12	undrained	<ul style="list-style-type: none"> Ensure the drain pipe in the right place drain height too high or not Ensure the drain-pipe has been blockage or not Ensure the drain-pipe length 	Press Start/Pause Button
H	Door can't be opened	<ul style="list-style-type: none"> Make sure don't use hot water The water temperature is high when washing Suspension of drying 	Automatic unlocking Until the temperature drops to safety
U4	Door not closed		Close the door, until the "locked" light on, confirm it then press "Start/Pause" to reoperation
Other code	Alarm		Press "Start/Pause" to reoperation, If still can't solve the problem, please contact the service center.

Maintenances

Technical Specifications

Power Supply 220-240V AC, 50Hz

MAX.Current 10A

Standard Water Pressure 0.03 MPa~1.0 MPa



Model	Washing Capacity	Machine Dimension (W*D*Hmm)	Net Weight	Rated Power
BD-802HVOW	8kg	600*600*850	63kg	1800W
BD-D802HVOW	Washer Dryer 8/5kg	600*600*850	64kg	1800/1450W
BD-904HVOW	9kg	600*600*850	67kg	1800W
BD-1054HVOS	10.5kg	600*635*850	70kg	1800W
BD-1054HVOW	10.5kg	600*635*850	70kg	1800W
BD-D1054HVOS	Washer Dryer 10.5/7kg	600*635*850	71kg	1800/1450W
BD-D1054HVOW	Washer Dryer 10.5/7kg	600*635*850	71kg	1800/1450W

Memo

A series of horizontal dashed lines for writing.

Sales and Service Center

Arcelik Hitachi Home Appliances Sales (Thailand) Ltd.

333, 333/1-8 Moo 13, Bangna-Trad Road, Km. 7, Bangkaew Subdistrict, Bang Phli District,
Samut Prakan Province 10540

Tel: 1529

Website: <https://www.hitachi-homeappliances.com/th-th/>

E-mail: service.h.ahst@arcelik-hitachi.com

LINE: @hitachithailand